

# SMD SPXO 5.0x3.2mm 1.8 - 5.0 VDC MHz

## SERIES "SXO"

### FEATURES

- + High reliability for low cost
- + Low-priced SMD-clock-oscillator
- + Frequency stability from  $\pm 20$  to  $\pm 100$  ppm available
- + Supply voltage of 1.8, 2.5, 2.8, 3.3 and 5.0 VDC deliverable
- + New standard for small low cost oscillators
- + Extended temperature range  $-40^{\circ}\text{C}$  to  $+125^{\circ}\text{C}$



PB FREE / ROHS COMPLIANT

### GENERAL DATA

PARAMETERS		PRODUCT FEATURES AND CONDITIONS		
SMD-OSCILLATOR SERIES		SXO-05032		
PACKAGE		Cermic package 5.0 x 3.2 x 1.2 mm <sup>3</sup>		
FREQUENCY RANGE		1.0~ 160.0 MHz		
FREQUENCY STABILITY		$-10/+60^{\circ}\text{C} \sim -10/+70^{\circ}\text{C}$		$\pm 20 \sim \pm 100$ ppm
		$-20/+70^{\circ}\text{C} \sim -40/+85^{\circ}\text{C}$		$\pm 25 \sim \pm 100$ ppm
		$-40/+85^{\circ}\text{C} \sim -40/+105^{\circ}\text{C}$		$\pm 50 \sim \pm 100$ ppm
		$-40/+125^{\circ}\text{C}$		$\pm 100$ ppm
		The frequency stability contains the frequency tolerance at 25°C, the temperature stability, supply voltage change and load change. The aging is $\pm 3$ ppm max. per year.		
OPERATING TEMPERATURE RANGE		$-10/+60^{\circ}\text{C} \sim -40/+125^{\circ}\text{C}$		
STORAGE TEMPERATURE RANGE		$-55/+125^{\circ}\text{C}$		
INPUT	CURRENT	FREQUENCY	+1.8 VDC $\pm 10\%$	
		1.0~4.0 MHz	10 mA max.	
		4.0~45.0 MHz	30 mA max.	
		45.0~112.0 MHz	45 mA max.	
		112.0~160.0 MHz	90 mA max.	
		FREQUENCY	+2.5 VDC $\pm 10\%$	+2.8 VDC $\pm 10\%$
		1.0~4.0 MHz	10 mA max.	10 mA max.
		4.0~45.0 MHz	30 mA max.	30 mA max.
		45.0~112.0 MHz	45 mA max.	45 mA max.
		112.0~160.0 MHz	90 mA max.	90 mA max.
		FREQUENCY	+3.3 VDC $\pm 10\%$	+5.0 VDC $\pm 10\%$
		1.0~4.0 MHz	10 mA max.	10 mA max.
		4.0~45.0 MHz	30 mA max.	30 mA max.
		45.0~112.0 MHz	45 mA max.	45 mA max.
112.0~160.0 MHz	90 mA max.	90 mA max.		

## GENERAL DATA (CONTINUED)

PARAMETERS		PRODUCT FEATURES AND CONDITIONS		
OUTPUT	SYMMETRY	STANDARD	40/60%	
		OPTION	45/55%	
	RISE AND FALL TIME		5 ns typical / 10ns max.	
	"0" LEVEL	TTL	0.4 V max.	
	"1" LEVEL		+2.4 V min.	
	"0" LEVEL	CMOS	10% VDD min.	
	"1" LEVEL		90% VDD max.	
LOAD		+1.8 VDC ~ +2.8 VDC ±10%	+3.3 VDC ±10%	+5.0 VDC ±10%
	TTL	1 ~ 5 TTL	1 ~ 10 TTL	1 ~ 10 TTL
	CMOS	15 pF max.	15 ~ 30pF (15pF typical)	15 ~ 50pF
PIN1	STANDARD	WITHOUT ENABLE / DISABLE FUNCTION		
	OPTION	WITH ENABLE / DISABLE FUNCTION		
ENABLE / DISABLE FUNCTION		PIN #1 (E/D CONTROL)	PIN #3 (OUTPUT)	
		OPEN	ACTIVE	
		HIGH "1" (VIH >70%VDC)	ACTIVE	
		LOW "0" (VIL <30%VDC)	HIGH IMPEDANCE	
		OUTPUT DISABLE TIME	150 ns max.	
		OUTPUT ENABLE TIME	10 ms max.	
DELIVERY FORM		Tape and Reel / 1.000 pcs. per reel, other quantities are available on request		
SELECT YOUR REQUIRED OSCILLATOR (PRODUCT CONFIGURATOR)		REQUEST OSCILLATOR SAMPLES (SAMPLE CONFIGURATOR)		

## OUTLINE DRAWING

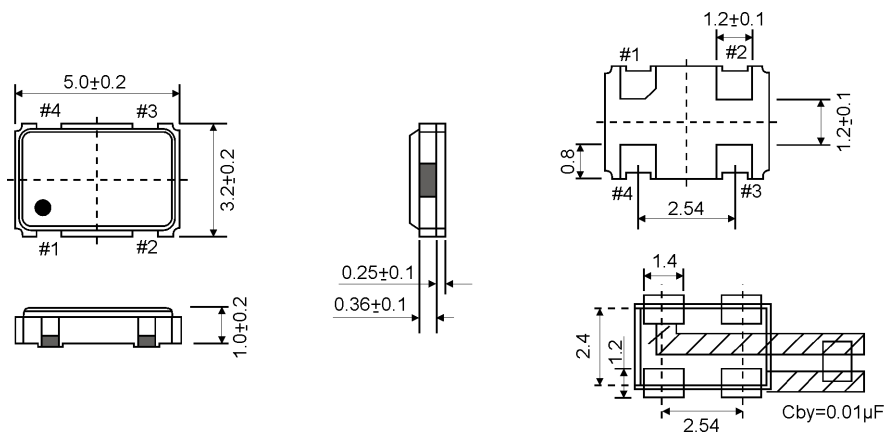

PIN	FUNCTION
#1	N.C. OR ENABLE / DISABLE
#2	GROUND
#3	OUTPUT
#4	VDD

Unit:mm

## REEL SPECIFICATION

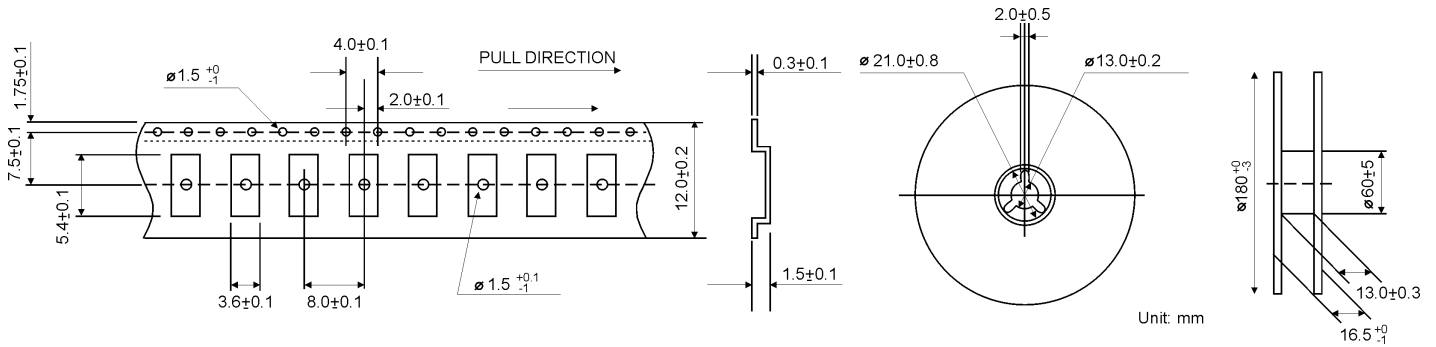

## TEST CIRCUIT FOR CMOS

## TEST CIRCUIT FOR TTL

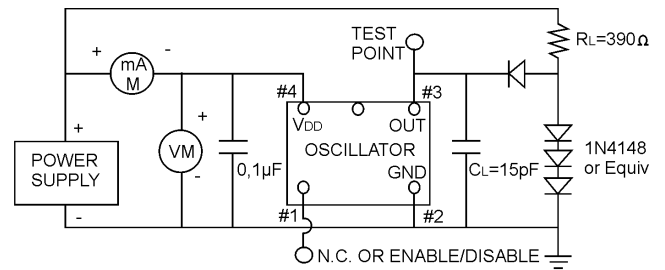
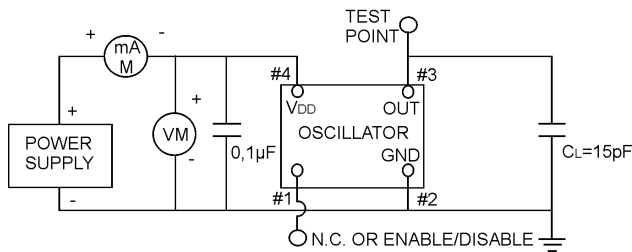

## OUTPUT WAVE FORM CMOS

## OUTPUT WAVE FORM TTL LOAD

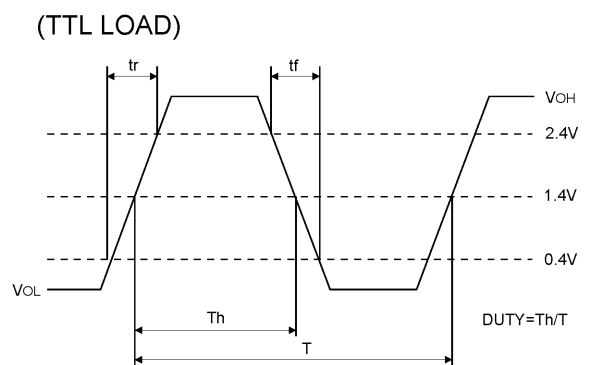
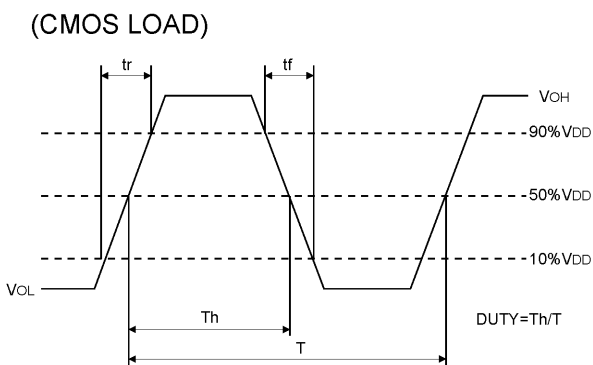

## REFLOW SOLDER PROFILE

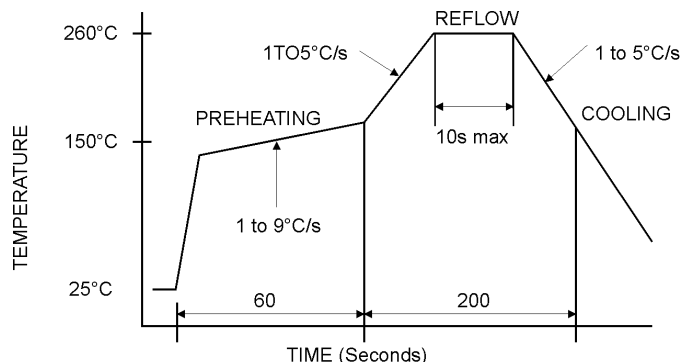

Oscillators can be soldered according to the norm JEDEC J-STD-020C.

## ORDERING INFORMATION

**SERIES & VOLTAGE**  
 SX018 = 1.8V  
 SX025 = 2.5V  
 SX028 = 2.8V  
 SX03 = 3.3V  
 SX0 = 5.0V

**SYMMETRY**  
 "-" = 40/60%  
 "S" = 45/55%

**FREQUENCY STABILITY**  
 "20" = ±20PPM  
 "25" = ±25ppm  
 "50" = ±50PPM  
 "-" = ±100PPM

**FREQUENCY RANGE**  
 1.0 - 160.0 MHz

SX018-05032-S-E-20-M-27.000MHz-T

**PACKAGE SIZE**  
 "05032" = 5.0X3.2MM

**PIN1**  
 "-" = NOT CONNECTED  
 "E" = ENABLED/DISABLED

**TEMPERATURE RANGE**  
 "-" = 0/+70°C  
 "N" = -10/+60°C  
 "M" = -20°/+70°C  
 "W" = -40°/+85°C  
 "Y" = -40°/+105°C  
 "Z" = -40°/+125°C

**DELIVERY FORM**  
 "T" = TAPE AND REEL

EXAMPLE: SX018-05032-S-E-20-M-27.000MHz-T  
 PLEASE INDICATE YOUR REQUIRED PARAMETERS



## PREMIUM QUALITY BY PETERMANN-TECHNIK



OUR COMPANY IS CERTIFIED ACCORDING TO ISO 9001:2015 IN OCTOBER 2016 BY THE DMSZ CERTIFIKATION GMBH.

THIS IS FOR YOU TO ENSURE THAT THE PRINCIPLES OF QUALITY MANAGEMENT ARE FULLY IMPLEMENTED IN OUR QUALITY MANAGEMENT SYSTEM AND QUALITY CONTROL METHODS ALSO DOMINATE OUR QUALITY STANDARDS.