

SMD VCXO 5.0x3.2mm 4 pad 3.3 - 5.0 VDC MHz

SERIES "VCXO"

FEATURES

- + High reliability for low cost
- + Frequency stability to ± 20 ppm
- + Available in 5.0 and 3.3 Volt
- + Extended temperature range -40°C to $+85^{\circ}\text{C}$
- + Applications: fibre channel, telecom, set-top box, broadband, etc.



PB FREE / ROHS COMPLIANT

GENERAL DATA

PARAMETERS		PRODUCT FEATURES AND CONDITIONS		
SMD-OSCILLATOR SERIES		SMD-VCX04		
PACKAGE		Ceramic package 5.0 x 3.2 x 1.3 mm ³		
FREQUENCY RANGE		1.0 ~ 40.0 MHz		
FREQUENCY STABILITY		± 20 ppm / ± 25 ppm / ± 50 ppm		
OPERATING TEMPERATURE RANGE		$-20/+70^{\circ}\text{C}$ ~ $-40/+85^{\circ}\text{C}$		
STORAGE TEMPERATURE RANGE		$-55/+125^{\circ}\text{C}$		
INPUT	VOLTAGE	$+3.3\text{VDC} \pm 5\%$ / $+5.0\text{VDC} \pm 5\%$		
	CURRENT	25 mA max.		
OUTPUT	SYMMETRY	STANDARD	40/60%	
		OPTION	45/55%	
	SIGNAL	CMOS/HCMOS		
	RISE AND FALL TIME	8 ns max.		
	"0" LEVEL	CMOS/HCMOS	0.4VDD max. or 10% VDD max.	
	"1" LEVEL		2.4VDD min. or 90% VDD min.	
LOAD	15 pF ~ 30 pF			
START-UP TIME		10 mS max.		
INPUT IMPEDANCE		10 kW min.		
MODULATION BANDWITH (BW)		5 kHz min.		
CONTROL VOLTAGE RANGE		$1.65\text{VDC} \pm 1.35\text{VDC}$ for $+3.3\text{VDC}$ / $2.5\text{VDC} \pm 2.0\text{VDC}$ for $+5.0\text{VDC}$		
CENTER VOLTAGE		1.65VDC for $+3.3\text{VDC}$ / 2.5VDC for $+5.0\text{VDC}$		
PULLING RANGE		± 50 ppm ~ ± 100 ppm min.		
LINEARITY		10% max.		
SLOPE		POSITIVE		
PHASE NOISE		-70dBc/Hz @10Hz		
		-130dBc/Hz @10kHz		
PIN CONNECTION	PIN 1	CONTROL VOLTAGE		
	PIN 2	GROUND		
	PIN 3	OUTPUT		
	PIN 4	SUPPLY VOLTAGE		
DELIVERY FORM		Tape and Reel / 1.000 pcs. per reel, lower QTY possible		
OTHER PARAMETERS ARE AVAILABLE ON REQUEST / CREATE HERE YOUR SPECIFICATION				

OUTLINE DRAWING

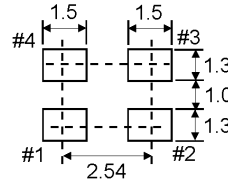
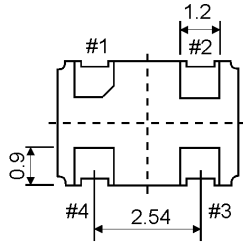
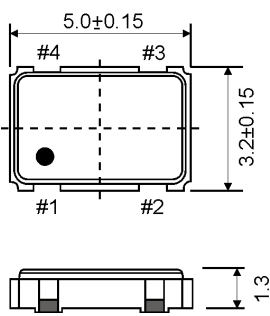

PIN	FUNCTION
#1	VOLTAGE CONTROL
#2	GROUND
#3	OUTPUT
#4	VDD

Unit:mm

REEL SPECIFICATION

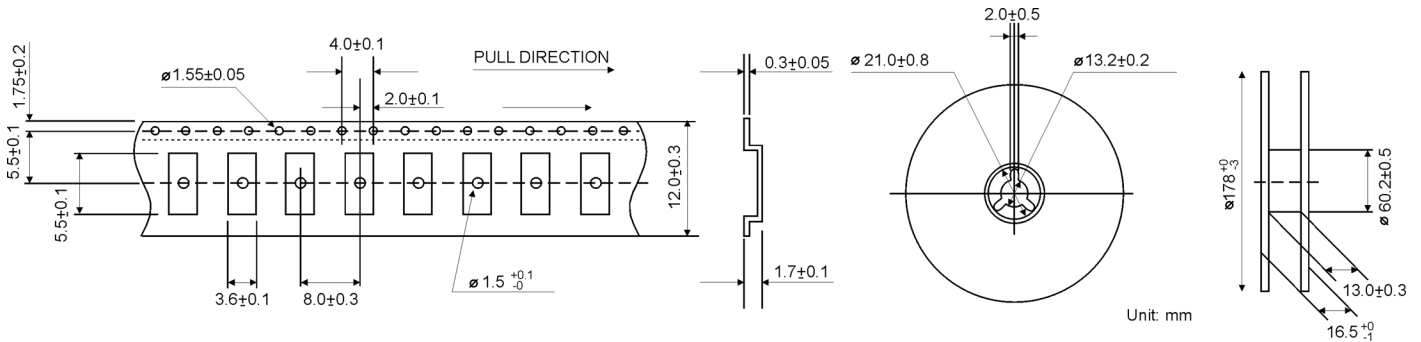

Unit: mm

TEST CIRCUIT CMOS

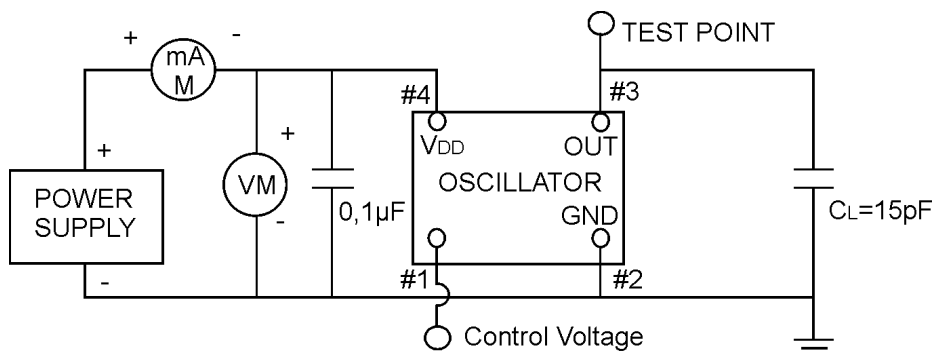

NOTE: CL includes probe and fixture capacitance

REFLOW SOLDER PROFILE

CMOS/HCMOS LOAD

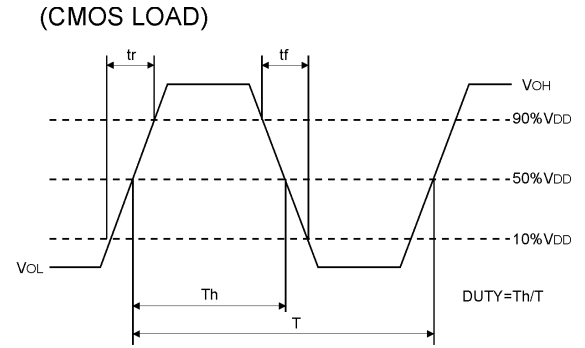
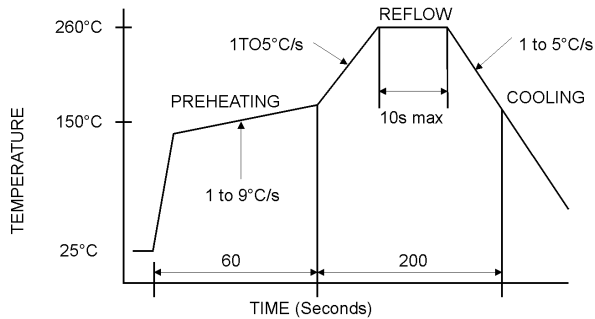

ORDERING INFORMATION

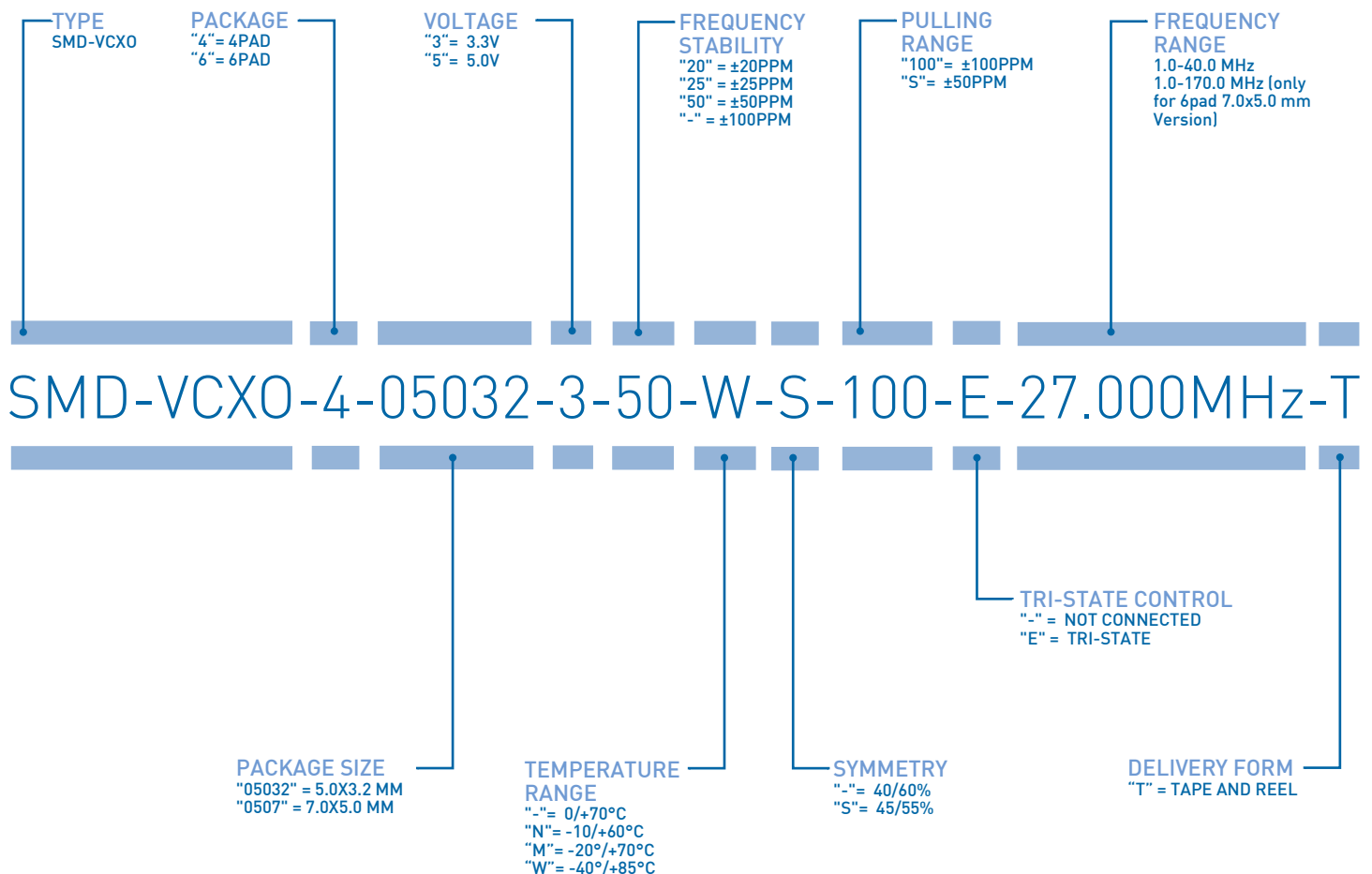

EXAMPLE: SMD-VCXO-4-05032-3-50-W-S-100-E-27.000MHZ-T
PLEASE INDICATE YOUR REQUIRED PARAMETERS



PREMIUM QUALITY BY PETERMANN-TECHNIK



OUR COMPANY IS CERTIFIED ACCORDING TO ISO 9001:2015 IN OCTOBER 2016 BY THE DMSZ CERTIFIKATION GMBH.

THIS IS FOR YOU TO ENSURE THAT THE PRINCIPLES OF QUALITY MANAGEMENT ARE FULLY IMPLEMENTED IN OUR QUALITY MANAGEMENT SYSTEM AND QUALITY CONTROL METHODS ALSO DOMINATE OUR QUALITY STANDARDS.