

SMD VCXO 5.0x3.2mm 6 pad 3.3 - 5.0 VDC MHz

SERIES "SX0"

FEATURES

- + High reliability for low cost
- + Frequency stability to ± 20 ppm
- + Available in 5.0 and 3.3 Volt
- + Extended temperature range -40°C to $+85^{\circ}\text{C}$
- + Applications: fibre channel, telecom, set-top box, broadband, etc.



PB FREE / ROHS COMPLIANT

GENERAL DATA

PARAMETERS		PRODUCT FEATURES AND CONDITIONS	
SMD-OSCILLATOR SERIES		SMD-VCX06	
PACKAGE		Ceramic package 5.0 x 3.2 x 1.3 mm ³	
FREQUENCY RANGE		1.0 ~ 40.0 MHz	
FREQUENCY STABILITY		± 20 ppm / ± 25 ppm / ± 50 ppm	
OPERATING TEMPERATURE RANGE		$-20/+70^{\circ}\text{C}$ ~ $-40/+85^{\circ}\text{C}$	
STORAGE TEMPERATURE RANGE		$-55/+125^{\circ}\text{C}$	
INPUT	VOLTAGE	$+3.3\text{VDC} \pm 5\%$ / $+5.0\text{VDC} \pm 5\%$	
	CURRENT	25 mA max.	
OUTPUT	SYMMETRY	STANDARD	40/60%
		OPTION	45/55%
	SIGNAL	CMOS/HCMOS	
	RISE AND FALL TIME	8 ns max.	
	"0" LEVEL	CMOS/HCMOS	0.4VDD max. or 10% VDD max.
	"1" LEVEL		2.4VDD min. or 90% VDD min.
LOAD	15 pF ~ 30 pF		
START-UP TIME		10 mS max.	
INPUT IMPEDANCE		10 k Ω min.	
MODULATION BANDWIDTH (BW)		5 kHz min.	
CONTROL VOLTAGE RANGE		1.65VDC \pm 1.35VDC for +3.3VDC / 2.5VDC \pm 2.0VDC for +5.0VDC	
CENTER VOLTAGE		1.65VDC for +3.3VDC / 2.5VDC for +5.0VDC	
PULLING RANGE		± 50 ppm ~ ± 100 ppm min.	
LINEARITY		10% max.	
SLOPE		POSITIVE	
PHASE NOISE		-70dBc/Hz @10Hz	
		-130dBc/Hz @10kHz	
PIN CONNECTION	PIN 1	CONTROL VOLTAGE	
	PIN 2	NOT CONNECT	
	PIN 3	GROUND	
	PIN 4	OUTPUT	
	PIN 5	ENABLE/DISABLE FUNCTION	
	PIN 6	SUPPLY VOLTAGE	
	OPTION	OTHER PIN CONNECTIONS AVAILABLE ON REQUEST	

GENERAL DATA (CONTINUED)

PARAMETERS	PRODUCT FEATURES AND CONDITIONS	
ENABLE / DISABLE FUNCTION	PIN 5 ENABLE/DISABLE	PIN 4 OUTPUT
	HIGH OR LEFT FLOATING	OSCILLATION
	LOW	HIGH IMPEDANCE
DELIVERY FORM	Tape and Reel / 1.000 pcs. per reel, other quantities are available on request	
OTHER PARAMETERS ARE AVAILABLE ON REQUEST / CREATE HERE YOUR SPECIFICATION		

OUTLINE DRAWING

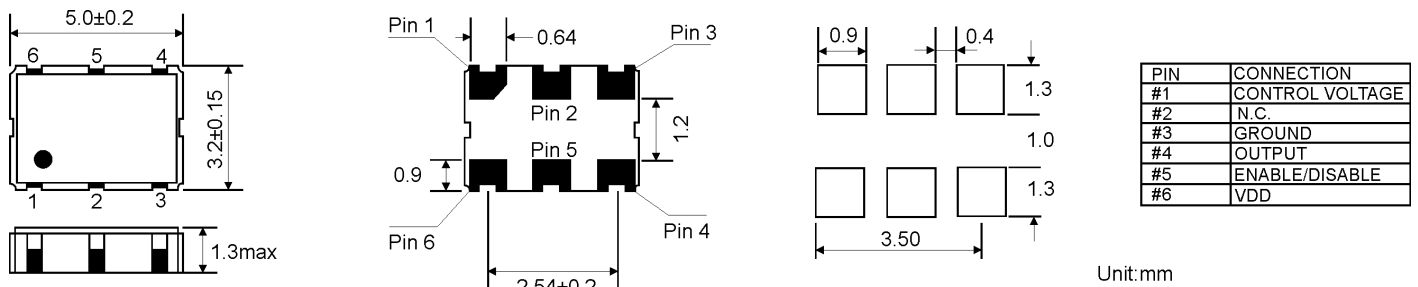

REEL SPECIFICATION

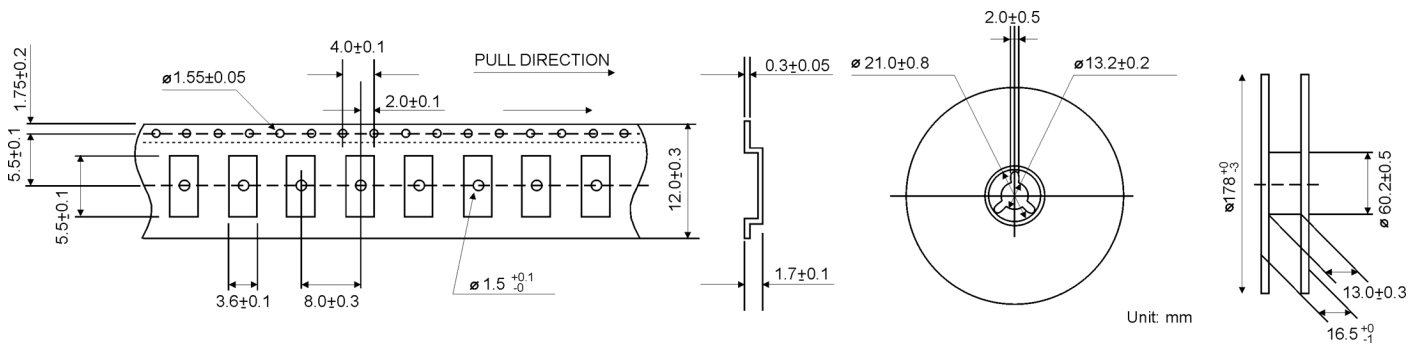

REFLOW SOLDER PROFILE

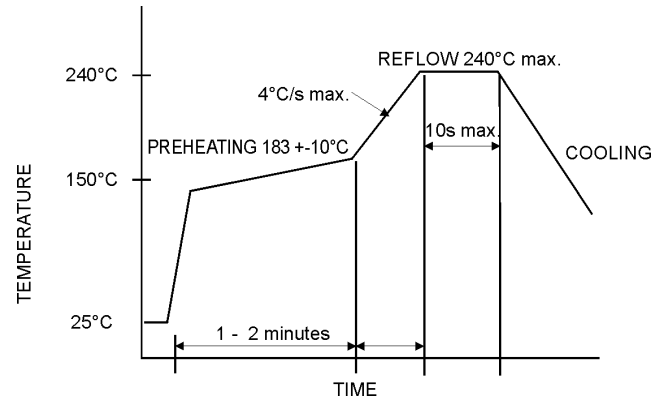

TEST CIRCUIT FOR CMOS/HCMOS

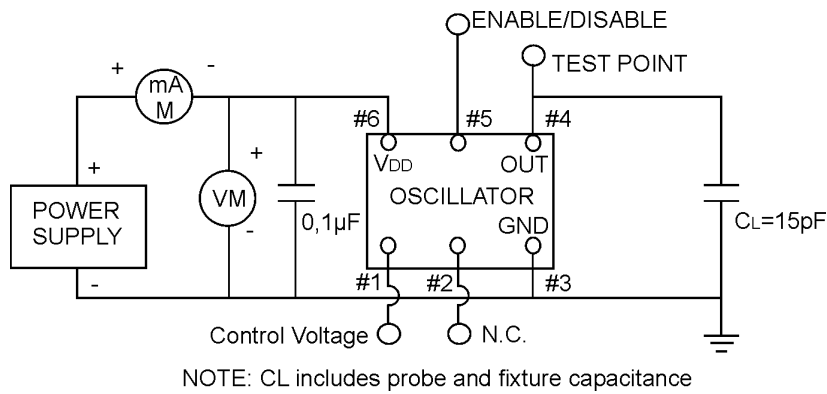

CMOS/HCMOS LOAD

TTL LOAD

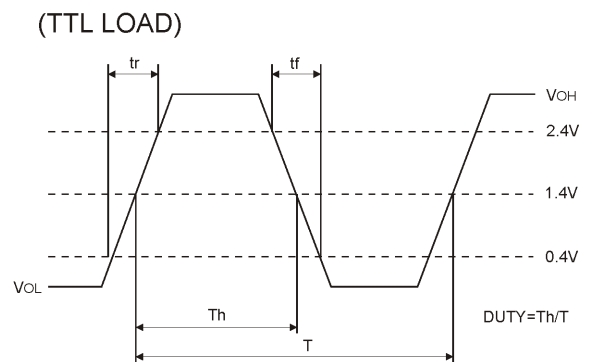
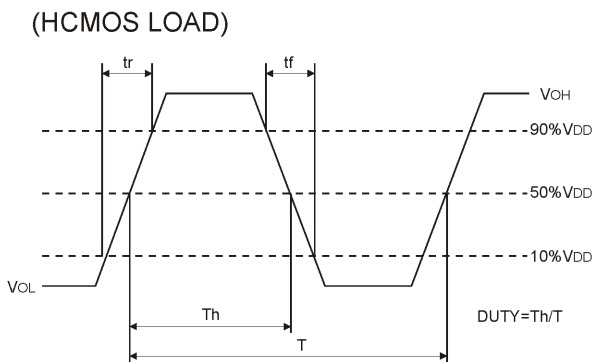



ORDERING INFORMATION

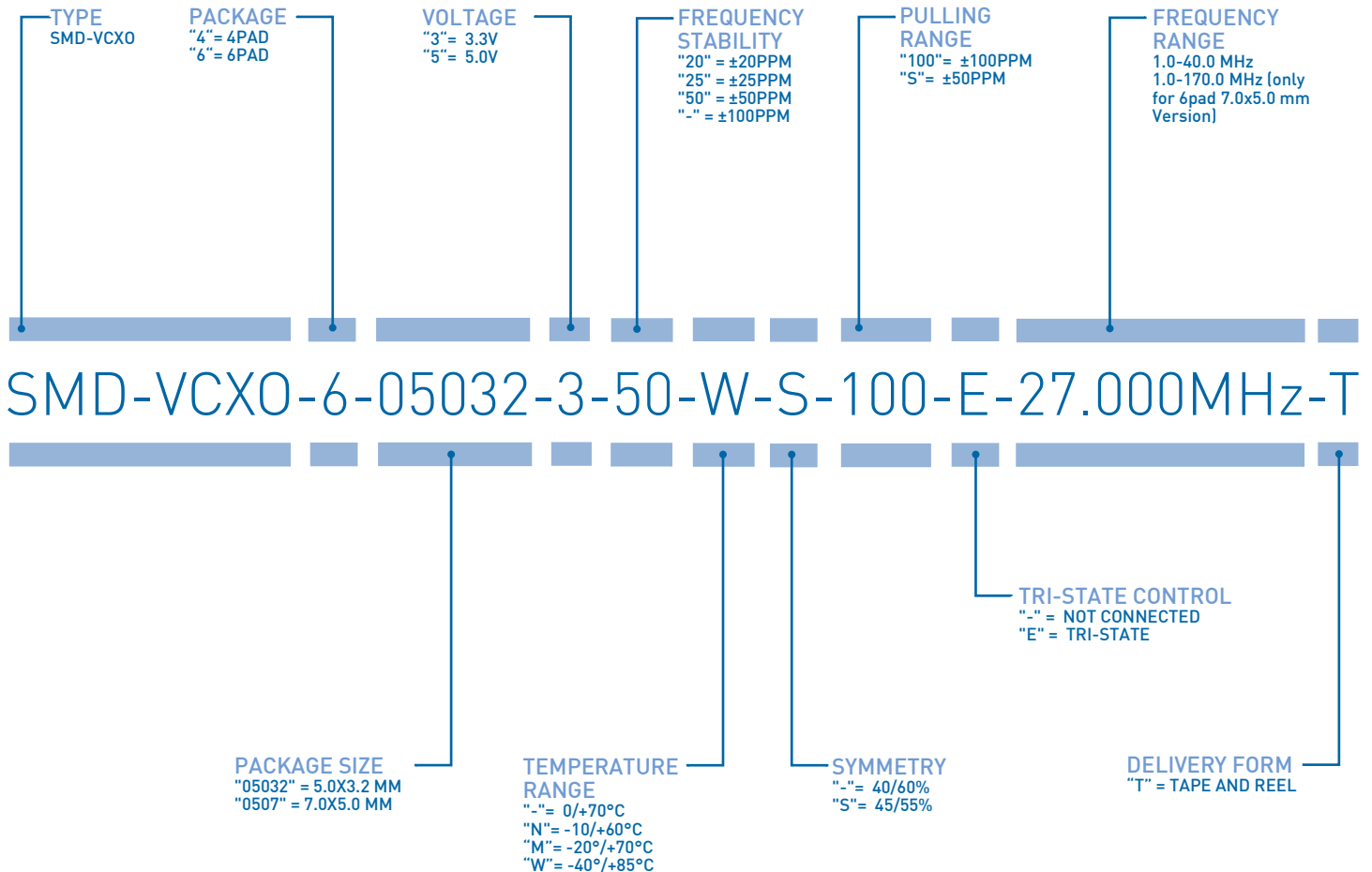

EXAMPLE: SMD-VCXO-6-05032-3-50-W-S-100-E-27.000MHZ-T
 PLEASE INDICATE YOUR REQUIRED PARAMETERS



PREMIUM QUALITY BY PETERMANN-TECHNIK



OUR COMPANY IS CERTIFIED ACCORDING TO ISO 9001:2015 IN OCTOBER 2016 BY THE DMSZ CERTIFIKATION GMBH.

THIS IS FOR YOU TO ENSURE THAT THE PRINCIPLES OF QUALITY MANAGEMENT ARE FULLY IMPLEMENTED IN OUR QUALITY MANAGEMENT SYSTEM AND QUALITY CONTROL METHODS ALSO DOMINATE OUR QUALITY STANDARDS.